

WÖHLER

Manual
HD inspection camera

EN

Wöhler VIS 750

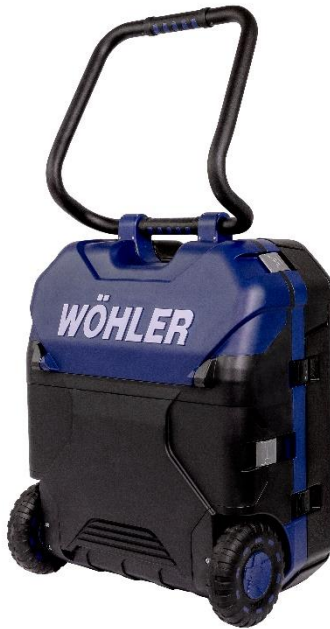

Order no. 25601 2025-04-22

The Measure of Technology

Contents

1	General information.....	5
1.1	Operation Manual Information	5
1.2	Copyright.....	5
1.3	Notes.....	5
1.4	Proper use.....	5
1.5	Scope of delivery fully equipped.....	6
1.6	Storage and transportation.....	6
1.7	Information on disposal	7
1.8	Manufacturer	7
2	Important notes.....	8
3	Technical data	11
3.1	Wöhler VIS 7 HD Monitor	11
3.2	Wöhler VIS 750 HD pan/tilt camera head (optional)	12
3.3	Wöhler VIS 750 HD miniature camera head (optional)	13
3.4	Reel with camera rod	14
3.5	Electronic meter counter	15
3.6	Storage.....	15
3.7	Recording duration	15
3.8	Trolley	15
4	Design and function	16
4.1	Wöhler VIS 750 HD inspection camera	16
4.2	Monitor	18
5	Starting to use the HD inspection camera.....	20
5.1	Positioning the trolley	20
5.2	First steps.....	21
5.3	Activating the battery.....	24
5.4	Screwing on the camera head.....	24
5.5	Using the monitor	27
5.6	Charging the battery.....	31
6	Key functions	32

6.1	On/off button.....	32
6.2	Video button.....	33
6.3	Photo button	34
6.4	Joystick.....	34
7	Display elements	35
8	Display of the position of the camera head	36
9	Home function.....	36
10	Digital meter counting.....	36
11	Live menu	37
11.1	Brightness menu.....	37
11.2	Focus menu	37
11.2.1	Focus adjustment via sliding bar.....	38
11.2.2	Focus adjustment via joystick	38
11.2.3	Focus adjustment by fingertip.....	38
11.3	Comment function.....	38
11.4	System menu.....	41
11.4.1	Activate WLAN.....	41
11.4.2	Locator.....	42
11.4.3	Save and delete images and videos	42
11.4.4	Display of photos and videos	44
11.4.5	Settings.....	45
11.4.6	Info menu.....	48
12	Distance measurement	49
12.1	Measuring accuracy Distance.....	49
12.2	Open and close distance measurement menu.	50
12.3	Set measuring points	50
12.4	Saving the measurement results	51
12.5	Calibrating the camera head.....	52
12.6	Reset calibration	53
13	Transfer of image files via WLAN	54
13.1	Access point: Transmission via a VIS 750 WLAN network.....	55

13.1.1	Select WLAN channel if required	55
13.1.2	Change password or network name.....	56
13.2	Client: Use of an existing WLAN network....	58
14	Malfunctions	60
14.1	Reset.....	60
14.2	Possible incidents.....	61
15	Maintenance	62
15.1	Notes on maintenance and care	62
15.2	Changing the dome of the camera head	62
15.3	Camera head	62
15.4	Monitor	62
15.5	Removing the reel	63
15.6	Cleaning the reel, bar and lower shell	66
15.7	Inserting the reel	67
16	Guaranty and Service	70
16.1	Guaranty	70
16.2	Service	70
17	Declaration of conformity	71
18	UKCA Declaration of Conformity	72

1 General information

- 1.1 Operation Manual Information** These operating instructions enable you to operate the Wöhler VIS 750 HD inspection camera safely. Please keep these operating instructions in a safe place for future reference.

The Wöhler VIS 750 HD inspection camera may only be used by qualified personnel for its intended purpose.

We accept no liability for damage caused by failure to observe these operating instructions.

1.2 Copyright

Without the prior written consent of Wöhler, it is not permitted to reproduce or translate this documentation or parts thereof, to copy, photocopy, reproduce or translate.

1.3 Notes



WARNING!

Indicates instructions which, if ignored, could result in injury or death.



ATTENTION!

Indicates hazards that could result in damage to the appliance.



NOTE!

Highlights tips and other useful information.

1.4 Proper use

The Wöhler VIS 750 HD inspection camera is designed for visual inspection and documentation in pipes and shafts, e.g. flue gas systems, ventilation systems, waste water pipes, etc.

The device may only be used by qualified personnel.

Any further use is considered improper use.

1.5 Scope of delivery fully equipped

Device	Scope of delivery
Wöhler VIS 750 HD inspection camera	Wöhler VIS 7 HD monitor unit
	Wöhler VIS 750 HD pan/tilt camera head Ø40 mm, pluggable incl. 10 replacement plastic couplings (optional)
	Wöhler VIS 750 HD miniature camera head Ø26 mm, pluggable (optional)
	Reel with 60 m camera rod (black) and 2 m connection cable to monitor (optional)
	Reel with 40 m camera rod (blue) and 2 m connection cable to the monitor (optional)
	1 plug-in power supply with USB-C cable
	Trolley

1.6 Storage and transportation

To avoid damage during transportation, the complete system must always be transported in the original trolley.

1.7 Information on disposal



Electronic devices must not be disposed of with household waste, but must be disposed of in accordance with the applicable environmental regulations.

Damaged batteries are considered hazardous waste and must be taken to the designated collection points for disposal.



1.8 Manufacturer

Wöhler Technik GmbH

Wöhler-Platz 1

33181 Bad Wünnenberg

Phone: +49 2953 73-100

Fax: +49 2953 73-96100

E-mail: info@woehler.de

www.woehler-international.com

2 Important notes

Personal protection



WARNING!

Do not point the camera head directly at your eyes when the camera is switched on. The LEDs are extremely bright and can dazzle the eyes.



WARNING!

When carrying and setting down the Wöhler VIS 750 HD inspection camera, bear in mind its weight (approx. 25-30 kg depending on the equipment). Set the trolley down carefully and push the trolley instead of carrying it.



WARNING!

Make sure you guide the bar in a controlled manner. Due to the flexible material, the camera rod can strike if it slips. Protect your eyes in particular.



WARNING!

In order to limit the exposure of persons to electromagnetic fields, a safety distance of 5 cm must be maintained when the locating transmitter is switched on and the user is temporarily or permanently in the vicinity of the camera head.

Working environment**WARNING!**

Ensure that the camera is standing securely and that people are held securely, especially when working at great heights, e.g. on the roof.

**WARNING!**

Before the inspection, rule out the possibility that the part to be inspected could be live.

**ATTENTION!**

Do not push the camera head into a heavily oily or acidic environment. Never use the camera head and rod to push away obstacles.

Operating temperature**ATTENTION!**

Do not use the camera at temperatures above 40°. High temperatures can damage the camera.

Resistance to water**ATTENTION!**

Only the camera head and the push rod are waterproof. Protect the trolley contents from water!

Impact resistance**ATTENTION!**

The camera system is not impact-resistant. Do not throw or drop the trolley!

Accessories**ATTENTION!**

Only use original Wöhler accessories and spare parts.

Connecting the camera heads to the rod

 **ATTENTION!**

Plug-in camera heads may only be screwed hand-tight when they are mounted on the camera rod. Never use tools to screw them on. A small gap between the camera head and the camera rod is normal.

Strong magnetic or electric fields

 **NOTE!**

Do not use the camera in the vicinity of television towers, mobile radios and other sources of magnetic or electric fields, as this may result in image interference.

External influences

 **NOTE!**

External influences such as static discharge can cause malfunctions. In this case, switch the camera off and then on again.

3 Technical data

3.1 Wöhler VIS 7 HD Monitor



Fig. 1: Monitor

Description	Specification
Dimensions housing	250 x 155 x 54 mm
Weight	860 g
TFT Display	7" / 16:9 format 1280 x 800 pixels
Charging cable	USB-C 5 V/3 A
Power supply	3,6 V, 14 Ah Li-Ion battery
Battery operating time	up to 4 h
Operating temperature	0 - 40 °C
Storage temperature	- 20°C - 50°C
WLAN function	Wireless LAN IEEE 802.11 b/g/n network standard 2412-2472 MHz, < 10dBm

3.2 Wöhler VIS 750 HD pan/tilt camera head (optional)

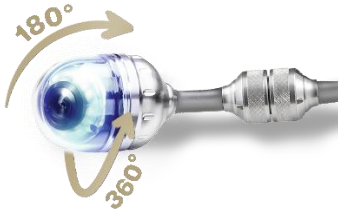
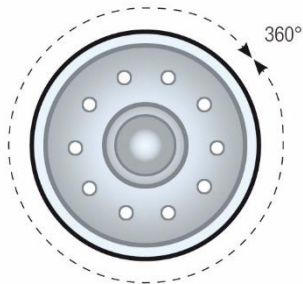
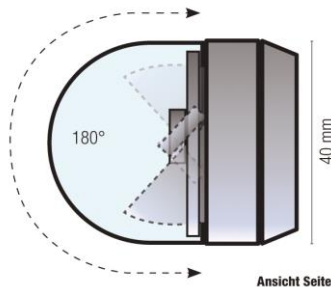

Fig. 2: Rotating and swiveling camera head



Ansicht Front

Fig. 3: Rotate 360°



Ansicht Seite

Fig. 4: Pivoting 180°

Description	Specification
Classification Type	1/2.7" Color CMOS
Focus distance	27 mm ... ∞
Light source	10 white LEDs
Protection	Waterproof to IP 67 (30 min. up to 1 m deep)
Dimensions	
Diameter	40 mm
Housing length	56 mm
Total length	approx. 102 mm
Frequency of the built-in transmitter	9.2 kHz
Image capture angle diagonal	70°
Working temperature	0 ... 40°C
Storage temperature	-20 ... 50 °C

3.3 Wöhler VIS 750 HD miniature camera head (optional)



Fig. 5: HD miniature camera head

Description	Specification
Type	1/2.7" Color CMOS
Light sources	10 white LEDs
Protection	Waterproof to IP 68
Waterproofness	max. 30 m depth
Dimensions	
Diameter	Ø 26 mm
Housing length	35.8 mm
Total length	80.6 mm
Frequency of the built-in transmitter	9.2 kHz
Image capture angle diagonal	150 °
Working temperature	0 ... 40°C
Storage temperature	-20 ... 50 °C

3.4 Reel with camera rod

Description	Blue rod	Black rod
Rod length	40 m	60 m
Rod dimensions	Ø 10 mm	Ø 10.6 mm
Minimum bending radius	approx. 190 mm	approx. 225 mm
Areas of application	DN 50 – DN 100 tubes	DN 75 – DN 150 tubes
Connection cable to the monitor	2 m	2 m

3.5 Electronic meter counter

Description	Specification
Resolution	26 mm
Max. deviation	5 % of reading

3.6 Storage

Description	Specification
Storage medium	Internal memory or USB stick with max. 32 GB (recommended by Wöhler)
Maximum recording time internal memory	5 h
Resolution of the saved recording	
Photo, with overlays (.png)	1280 x 800 pixels
Photo, without overlays (.png):	1280 x 720 pixels
Video (.AVI):	1280 x 720 px

3.7 Recording duration

Description	Specification
Max. Video recording duration (video ends automatically)	29 minutes and 59 seconds (29:59 min)

3.8 Trolley

Description	Specification
Dimensions	39 x 56 x 70 cm (LxWxH)
Total weight with monitor, camera head and camera rod	26.4 kg

4 Design and function

4.1 Wöhler VIS 750 HD inspection camera

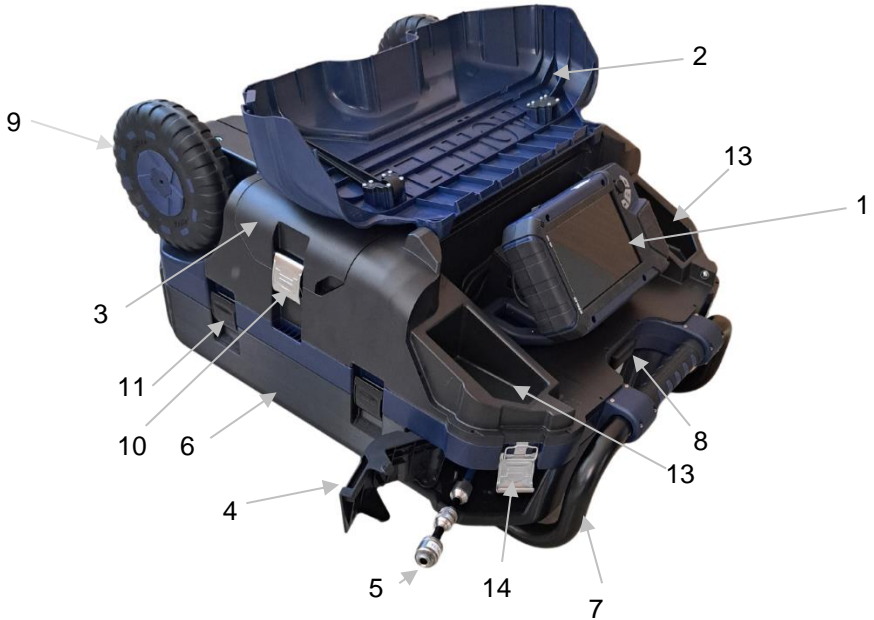

Fig. 6: Wöhler VIS 750 HD inspection camera



Fig. 7: Monitor with stand

Legend:

- 1** Monitor
- 2** Front flap
- 3** Accessory compartment flap
- 4** Camera flap
- 5** Camera head
- 6** Lower shell with reel basket (inside)
- 7** Bow handle
- 8** Push button
- 9** Wheel
- 10** Lock for accessory compartment flap
- 11** Closure for lower shell
- 12** Pedestal
- 13** Storage compartments for camera heads
- 14** Closure for front flap

4.2 Monitor



Fig. 8: Monitor



Fig. 9: Monitor underside with connection strip

Legend:

- 1 Fastening openings for the glare shield
- 2 Handle, inserted in the picture
- 3 Connection strip on underside
- 4 Loudspeaker
- 5 Microphone
- 6 CTIA standard connection for headset with headphones and microphone
- 7 USB connection for stick
- 8 USB-C port for charging cable
- 9 Notch for attaching to the trolley connecting rail

**! ATTENTION!**

When inserting the USB flash drive, ensure that the label is facing downwards. Never force the stick in!

Fig. 10: Insert USB stick correctly

5 Starting to use the HD inspection camera

5.1 Positioning the trolley

Depending on the type of application, the trolley can be set up in 3 positions:

- Standing



Fig. 11: Wöhler VIS 750 HD inspection camera in upright position



Fig. 12: Wöhler VIS 750 HD inspection camera in horizontal position

- horizontal



Fig. 13: Wöhler VIS 750 HD inspection camera in semi-recumbent position

- Semi-recumbent

5.2 First steps



Fig. 14: Velcro on the monitor cable



Fig. 15: Velcro tape at the end of the rod



NOTE!

The reel cage monitor cable and the pole end are each attached to the reel cage with Velcro for shipping. Remove the Velcro before first use.

- Remove the Velcro tape of the monitor cable.

- Remove the Velcro from the end of the rod.

- Now place the reel basket in the trolley. To do this, proceed as follows:



ATTENTION!

If the reel basket is not used as described in these instructions, this may result in damage to the reel basket.



- First open the lower shell.
- Pull the connection cable through the opening in the reel holder.

Fig. 16: Pull the connection cable through the opening in the reel holder.

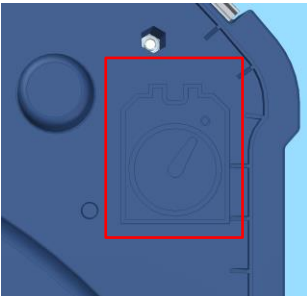

Fig. 17: Helpful illustration showing how the reel is used



Fig. 18: Correct fit of the reel



NOTE!

On the inside, there is an illustration showing how to use the reel correctly. The rod outlet points diagonally upwards to the right.

When inserting the reel, ensure that the rod outlet is pointing slightly upwards and to the right, as shown in the illustration.



ATTENTION!

The connection cable must be pulled completely through the opening of the reel holder and must not be pinched between the reel basket and the reel holder in the centre section under any circumstances. Otherwise, the reel basket may be damaged.



Fig. 19: Place the lower tray on top

- Place the lower shell on top and secure it with the four black clips.
- Insert the camera flap and place the trolley in an upright position.



Fig. 20: Closing the front flap

- Open both locks on the front flap.
- Fold down the front flap.



NOTE!

All flaps on the Wöhler VIS 750 HD inspection camera are completely removable. To do this, pull on the respective flap to release it from the holder. If you want to reinsert the corresponding flap, put it back in its original position and snap the respective flap into place.



Fig. 21: The front flap should engage clearly when inserted

- If you want to reinsert the front flap, turn it back to its original position. Now press the front flap back into the holder. The push buttons should click into place.
- Then close the two catches on the front flap.

5.3 Activating the battery

If the camera system cannot be switched on during initial commissioning, you have two options for activating the battery:

- Connect the monitor to the mains via the mains adapter, see chapter 5.6. Switch on the camera system.
The camera can then be switched on without a connection to the mains.

or

- Carry out a reset 1, see chapter 14.1

5.4 Screwing on the camera head

- Open the camera flap in front of the rod outlet (Fig. 6part 4).
- Remove the transport lock.



Fig. 22: Transport lock on the camera head



Fig. 23: The transport lock can be stored in the camera flap



Fig. 24: Removable camera flap

- The transport lock can be stored in the camera flap while the camera system is in use.

- The camera cover can also be removed completely. To do this, press the camera flap downwards. The camera flap then detaches from the holder.

- Pull the bar spout out of the trolley.
- If the camera head is not yet connected to the camera head, connect it as follows:
Plug the 7-pin connector of the camera head into the socket of the camera rod.
Then screw the threaded parts of the camera head and camera rod together.

! ATTENTION!

Only a tight screw connection ensures a watertight connection. However, a small gap is normal. In any case, only screw the camera head hand-tight.



Fig. 25: Attaching the transport lock

- After the inspection with the camera system, push the camera rod and, if necessary, the camera head back into the trolley until you feel resistance.
- If the camera head remains connected to the camera rod, replace the transport lock on the camera head. To do this, slide the transport lock onto the four pins.

5.5 Using the monitor



Fig. 26: Swivel monitor

- The monitor can be swiveled back and forth. To do this, drag the monitor to the desired angle.



Fig. 27: Transport position of the monitor

- To push the monitor back into the transport position, press the bottom of the monitor into the flat position.



Fig. 28: Monitor pulled out of the trolley holder

It is also possible to pull the extended monitor out of the holder and hold it in your hand. The stand can remain on the monitor or in the trolley.

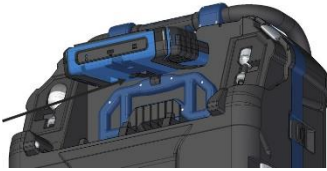

Fig. 29: Fold up the monitor and press the black lever

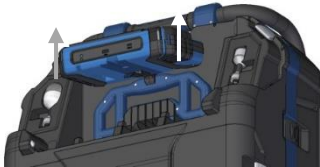

Fig. 30: Pull the monitor up to remove it and the stand from the holder



Fig. 31: Roll up the connection cable before pushing the monitor back in.

Handle



Fig. 32: When the handle is extended, the monitor can be held and operated with one hand.

To pull the monitor out of the holder without the stand:

- Fold up the monitor.
- Press the black lever on the back of the monitor.
- At the same time, remove the monitor from the holder.

To pull the monitor with stand out of the holder:

- Hold the monitor with both hands on the left and right and pull it up.
- The stand is noticeably disengaged.

If you want to place the monitor with stand back in the trolley, roll up the connection cable.

Slide the stand into the holder until it clicks into place.



ATTENTION!

If you feel resistance when pushing the monitor back, check that the connection cable is rolled up and not kinked under the monitor.

A handle can be pulled out so that the monitor can be held in the right hand and the joystick can be operated with the right hand at the same time.



- To pull out the handle, press the black push button on the top of the monitor and simultaneously slide the handle to the right.

Fig. 33: Push button for pulling out the handle marked with an arrow

Glare protection



Fig. 34: Wöhler VIS 750 HD inspection camera in horizontal position with glare shield



Fig. 35: Wöhler VIS 750 HD inspection camera in upright position with anti-glare protection



Fig. 36: Attaching the front flap

- The front flap of the trolley is also a glare shield. Open the front flap and position the pen on the left-hand side in the front flap according to your working position.
- If you are using the Wöhler VIS 750 HD inspection camera in the upright position, first remove the front flap completely after opening it (see chapter **Fehler! Verweisquelle konnte nicht gefunden werden.**).
- Turn the front flap over so that the Wöhler logo is at the top. Now insert the front flap above the monitor. The front flap should click into place. Position the pin on the left-hand side of the front flap according to your working position.
- If you want to close the front flap again, turn it back to its original position. Now press the front flap back into the holder; the push buttons should click into place.
- Then close the two catches on the front flap.

5.6 Charging the battery



Fig. 37: Battery icon, 60%



Fig. 38: USB socket marked with arrow

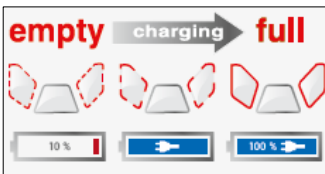

Fig. 39: Buttons and battery display during the charging process



WARNING!

Danger to life from electric current!

Never touch the mains plug with wet hands!

Keep the power supply unit away from moisture!

Do not pull the power supply unit out of the socket by the cable, it could tear!

Only operate the power supply unit if the electrical voltage specified on the rating plate matches that of the socket outlet!

A battery status symbol is located on the right-hand side of the display header. The battery status is displayed in blue or orange ($\leq 20\%$).

If the battery level is displayed in red ($\leq 10\%$), the battery should be charged.

- To charge the battery, connect the monitor to the mains connection using the mains adapter supplied.
- To do this, plug the USB-C connector into the USB socket on the underside of the monitor.

When the camera system is switched off, the photo and video buttons flash red during the charging process.

When charging is complete, the photo and video buttons light up red.

The camera system is fully functional during the charging process.



NOTE!

If possible, charge the battery when the camera system is switched off. This will increase the service life of the battery.

If the battery is being charged when the camera system is switched on, the buttons do not flash. A plug symbol appears in the battery indicator on the display.

6 Key functions

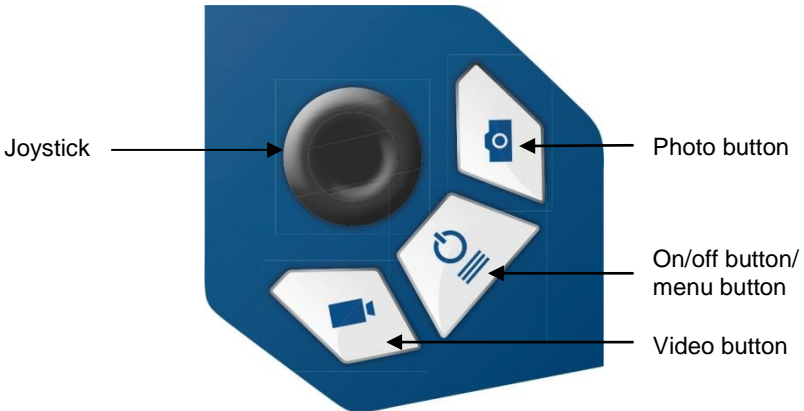

Fig. 40: Monitor buttons

6.1 On/off button



The fan can be heard at irregular intervals while the camera is in operation.

Switching on the system

- With the system switched off, press the On/Off button for approx. 1 second. The On/Off button then lights up green and the photo and video buttons light up blue.

After approx. 5 seconds, the LEDs on the camera head switch on. A start screen and then the camera image appear on the display.



It is possible to rotate the monitor by 180°. The header and footer of the monitor shown in the picture automatically align themselves with the position of the monitor. The screen view can also be rotated by tilting the monitor slightly.

Switching off the system

- Press the On/Off button for approx. 2 seconds until the system switches off.

Menu call

- Briefly press the On/Off button when the system is switched on to display the menu.
- Briefly press the On/Off button again to hide the menu.

6.2 Video button

- Press the video button briefly to start a video recording.
- Briefly press the video button again to end a video recording.

During video recording, a red dot appears in the footer of the display. The recording time of the video is also displayed in the footer.

**NOTE!**

If no USB stick is inserted, the video is saved in the camera's internal memory.

If a USB stick is inserted, the video is saved on the USB stick.

**NOTE!**

Always use a short USB stick, as a long USB stick could break off in the trolley. We recommend a Wöhler USB stick.

**NOTE!**

It is not possible to save the position display during video recording.

If this information is required, it is advisable to take a photo during the video. All information is displayed as graphic elements in the photo.

Duration of the recording**NOTE!**

After a video recording time of 29:59 minutes, the camera stops recording automatically. If a video is to be recorded over a longer period of time, the user must restart the recording after 30 minutes by pressing the video button.



NOTE!

The minimum recording time is 10 seconds. Even if the user stops the recording beforehand, the camera only stops recording after 10 seconds.

6.3 Photo button

- Press the photo button briefly to take a photo. It is possible to take a photo during a video recording.



NOTE!

The photo contains all the information shown on the display. In the settings menu, it is possible to set the photo to be saved without information, see 11.4.5.



NOTE!

If no USB stick is inserted, the photo is saved in the camera's internal memory.

If a USB stick is inserted, the photo is saved on the USB stick.

6.4 Joystick

Swivel by 180 °

Rotate 360°

- Move the joystick up and down to pan the camera head.
- Move the joystick to the left or right to rotate the camera head.

7 Display elements

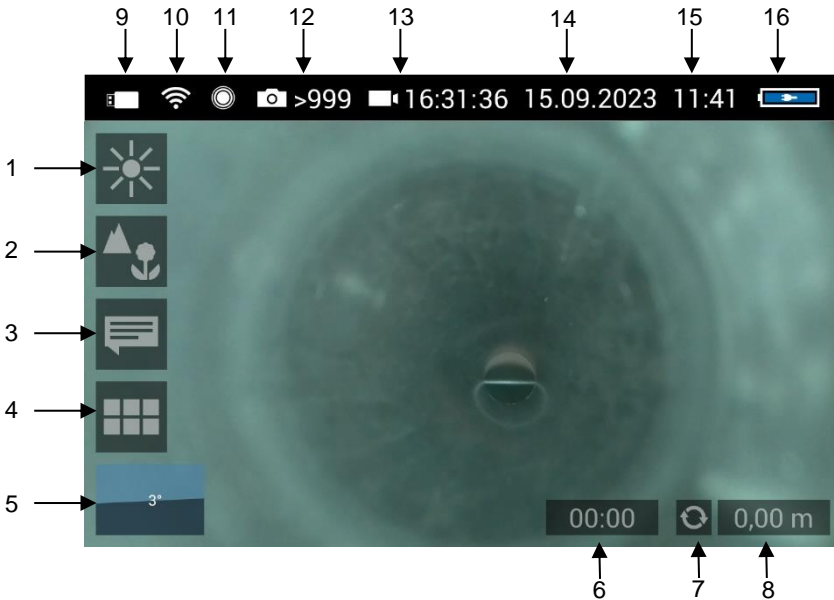

Legend:

- 1 Brightness control
- 2 Focus control
- 3 Comment function
- 4 System menu
- 5 "Horizon" with tilt and rotation angle display/home function
- 6 Video recording time
- 7 Reset meter counter
- 8 Meter counter
- 9 USB stick inserted (icon disappears as soon as USB stick is removed)
- 10 WLAN active
- 11 Locator
- 12 Number of images still available
- 13 Remaining video recording time
- 14 Date
- 15 Time
- 16 Remaining battery capacity

8 Display of the position of the camera head

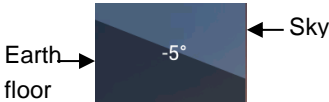

Fig. 41: Horizon icon with degree indication

9 Home function

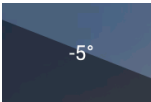

Fig. 42: Tap the horizon icon to straighten the camera head

10 Digital meter counting



Fig. 43: Reset icon (left) and position of the camera head (right)

The horizon icon indicates the gradient of the pipe.

Example illustration:

- 5° corresponds to a 5° gradient

(+ 5° corresponds to 5° gradient)

The home function enables the camera head to be automatically aligned in a straight position so that the camera is facing "forwards" and the rotation angle display appears parallel to the ground.

- To activate the home function, tap the horizon symbol on the display.

The meter display shows you how far the camera head has been pulled out of the trolley. To determine the exact position of the camera head in the tube, proceed as follows:

- Move the camera head to the start of the pipe and tap the reset icon.

The position marker is now at 0.

11 Live menu



The camera system settings can be made via the menu.

- When the system is switched on, briefly tap the On/Off/Menu button to display the menu

The following buttons appear:

Brightness, Focus, Comment, System menu

- Briefly tap the On/Off/Menu button again to hide the menu again

All menu settings are made via the touchscreen. As soon as a slider bar appears on the display, the setting can be made using both the touchscreen and the joystick. This is the case for the focus menu and the brightness menu.

11.1 Brightness menu



Fig. 44: Brightness menu icon

The brightness menu can be used to adjust **the brightness of the camera head LEDs.**



NOTE!

However, the display lighting can be changed in the settings menu, see chapter 11.4.5.

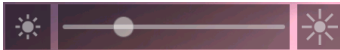

Fig. 45: Brightness slider bar

- Tap on the "Brightness" menu icon.
- To reduce or increase the brightness,
 - Use the joystick to drag the dot on the slider bar in the desired direction
 - or
 - Tap on the suns next to the slider bar or drag the point on the slider bar in the desired direction with your finger.
- To exit the brightness menu, press the joystick or tap another menu on the display.

11.2 Focus menu



Fig. 46: Focus menu icon



NOTE!

The focus function of the Wöhler VIS 750 HD inspection camera is only active when the Wöhler HD pan and rotate camera head \varnothing 40 mm is connected, not when the HD miniature camera head \varnothing 26 mm is connected. The miniature camera head has a fixed focus.

The focus function allows you to set which area of the image should be displayed in focus. You have 3 options for setting the focus: via the touchscreen using the slide bar, with the joystick or via the touchscreen by tapping.

11.2.1 Focus adjustment via sliding bar



Fig. 47: Focus slider bar

- Tap the "Focus" menu icon on the display to call up the slider bar.

- To move the focus, move the dot on the slider bar or tap on Flower or Mountain.

11.2.2 Focus adjustment via joystick

- Briefly press the joystick to activate the focus function.
- Move the joystick to the left or right to move the focus.

11.2.3 Focus adjustment by fingertip



Fig. 48: Focus adjustment with distance insertion

- Briefly tap the image area that you want to focus on on the screen.

The camera now automatically focuses on this area. The distance between the camera and the selected image area is displayed for a short time as additional information. For example, the distance of a damaged area from the camera can be determined and documented.

11.3 Comment function

The comment function allows you to add and save written comments to an image or video. The comments appear at the top right of the image or video.



NOTE!

A commentary can also be activated and deactivated in real time during the video.

It is not possible to add a comment to an image or video after it has been saved.

Add a comment

- Tap the "Comment" menu icon on the display.



Add comment to the comment list

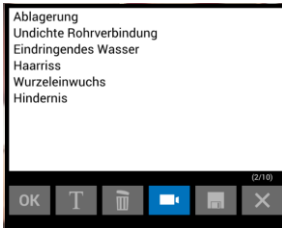

Fig. 49: Comment list

The comment list appears with predefined comments.

- Tap on the text icon **T** to create a new comment.
- Enter the comment using the keypad.
- Tap **OK** to add the new comment to the comment list. It will then also appear when you call up the comment list again.

Edit comment

- Tap on the comment to be changed so that it is highlighted in blue.
- Tap **T** to edit the selected comment using the keypad.



NOTE!

To cancel the selection, tap **X**.

Add a comment to an image or video

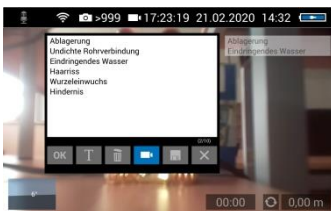

Fig. 50: Two comments have been selected and are displayed in the video (video button activated). The number of comment lines already occupied is displayed directly below the comment list (2 of 10 possible lines)

- To add a comment to an image or video, tap on the comment in the list so that it is highlighted in blue.
- Now tap OK to select it.



NOTE!

You can select up to 10 comment lines to save them in the image or video.

The selected comment lines now appear at the top right of the screen.

- If the video button is activated, the selected comments can be saved together with a video.
- If the video button is not activated, the selected comments can be saved with an image.

Delete comment from the comment list



- Tap on a comment in the comment list and then on the trash icon to delete the comment from the comment list. It will then no longer appear even if you call up the comment function again.

Save comment list



- Tap the save icon if you want to save the current comment list permanently.

The memory symbol is then colored blue for 2 seconds.

If you hide the comment list without first saving your new comment, the new comment will no longer be available.

Delete comment from image

- Select the comment in the image (not in the comment list) and then tap the trash can icon to delete the comment from the image.

Exit comment menu



- Tap X to exit the comment menu.

11.4 System menu

The system menu takes you to the following submenus:

WLAN, localization, picture and video gallery, settings.

Active functions are highlighted in blue, inactive functions in gray.

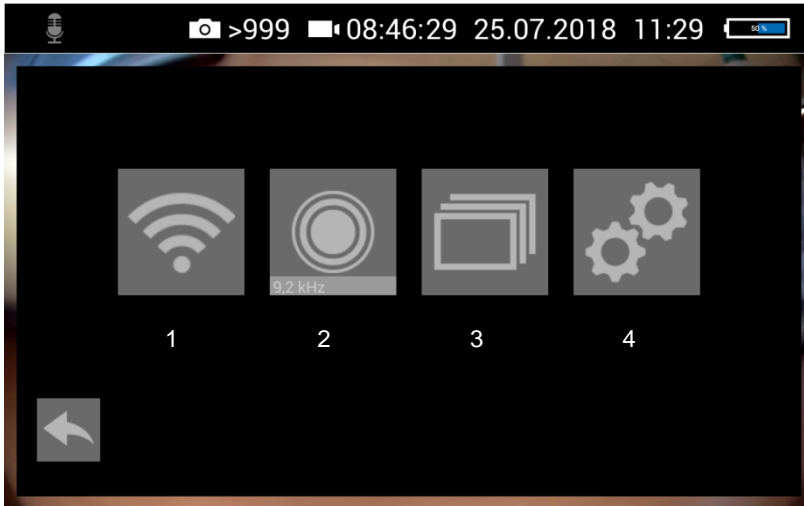

Fig. 51: System menu with the submenus WLAN (1), Locating (2), Picture and video gallery (3) and Settings (4)

11.4.1 Activate WLAN

This function is described in chapter 13 described in detail.



Fig. 52: WLAN icon

11.4.2 Locator



Fig. 53: Locator icon

- Tap on the location icon to activate the location transmitter.

The camera head can now be localized with the Locator Wöhler L 200.

The transmission frequency of the connected camera head is displayed below the locator icon.

The frequency can be changed between 9.2 kHz, 8.9 kHz and 512 Hz by tapping on the transmission frequency.

- After selecting the transmission frequency, activate the locating transmitter to save the new selection.

The last selected transmission frequency is retained when the camera is restarted.



NOTE!

In Europe, transmission is only permitted at 9.2 kHz (default setting).

11.4.3 Save and delete images and videos



Fig. 54: Image and video gallery icon

- Photos and videos are automatically saved to the internal memory if no USB stick is inserted.
- If a USB stick is inserted, photos and videos are automatically saved on it.

All recorded images and videos are displayed in the image and video gallery. The respective file name is made up of the date and time of the recording.

Select all files



Fig. 55: List icon

Tap on the list icon to select or unselect all files.

Saving files from the internal memory to a USB stick

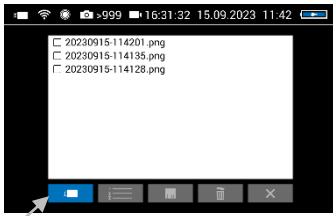

Fig. 56: Image gallery, USB icon marked with arrow.



Fig. 57: Memory icon



Fig. 58: Recycle bin icon

- Connect a USB stick to the monitor **before calling up the picture and video gallery.**



NOTE!

Always use a short USB stick, as a long USB stick could break off in the trolley. We recommend the Wöhler article 11269.

- Select the files to be saved in the internal memory.



NOTE!

A gray USB icon indicates that the internal memory is selected. A blue USB icon indicates that the USB stick is selected.

- To do this, tap on the square next to the files. A blue square indicates that the file is selected.
- Then tap on the save icon in the footer.
- The storage icon is now blue and the images are copied to the USB stick. This process may take a few seconds.



NOTE!

Never remove the USB flash drive immediately after you have deleted or copied files to it. In this case, there is a risk of data loss. Always leave the gallery before removing the stick.

-
- Select the files to be deleted by tapping on the square next to them. A blue square indicates that the file is selected.

Then tap on the recycle bin icon.

11.4.4 Display of photos and videos

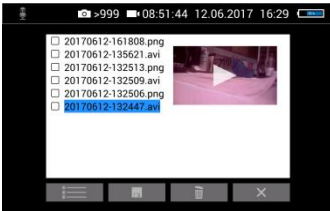

Fig. 59: Preview of selected video

How to playback videos on a PC

Leave picture gallery

- Tap on a file name in the picture and video gallery.
- A photo or video preview appears next to the file list.
- Tap on the preview. The photo or video will now be displayed.



NOTE!

Depending on the size of the video file, it may take a few seconds for the video to load and be ready for playback.

To return to the gallery, tap on the photo again or on the close icon in the video.



NOTE!

During video playback, the date, time and meter count are always displayed in the video, regardless of which media player is used.

If you have saved a video on your PC, you can play it on your PC using Windows Media Player or VLC Player. If you are working with a Windows PC, the Media Player is already installed. You can download the VLC Player free of charge from the website www.vlc.de.



NOTE!

Depending on the size of the video file, it may take a few seconds for the video to load and be ready for playback.

Tap the **X** to exit the picture and video gallery.

11.4.5 Settings



NOTE!

The settings made here are saved automatically and are retained after the camera system is switched off and on again.

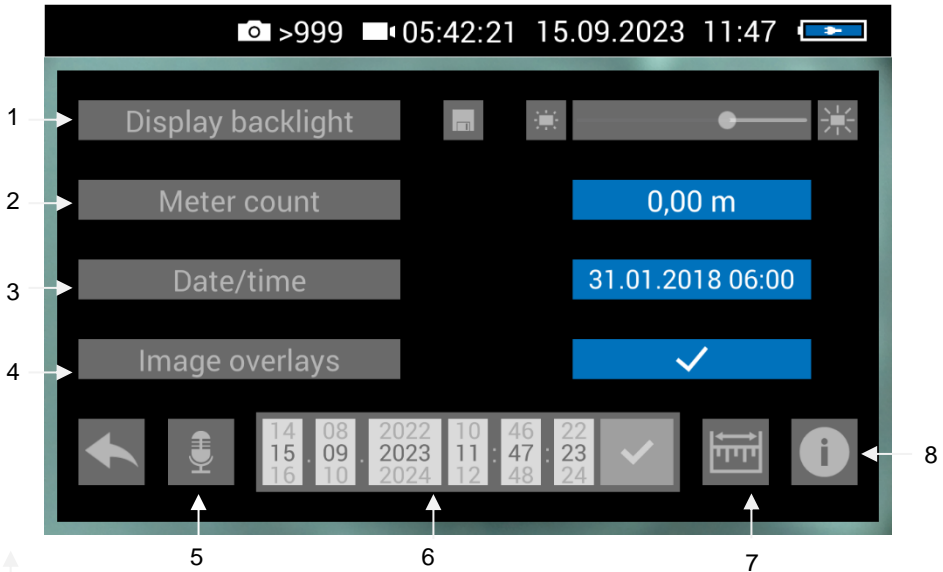

Fig. 60: Settings menu

1 Display illumination



The backlight of the display can be set here. To set the illumination of the camera head, however, see chapter 7.

When the camera is switched on, the display brightness is always set to 70%.

- To change the display lighting, tap on the light icons next to the slide bar or move the dot on the slide bar.

The display brightness can be adjusted in 10 steps from 10% to 100%.

If you want the display brightness setting to be retained even after switching on again, tap the memory symbol next to the slider bar.



NOTE!

To reduce power consumption when the battery is low, we recommend selecting a low display light.

2 Meter counting

The unit of meter counting can be changed here. The following options are available:

0.00 m (meter)

0.0 ft. (foot)

- To change the unit, tap on the blue unit field.

3 Date/time

The date and time display can be changed here as follows.

GERMAN:

Day.month.year

00.00 - 24.00

INTERNATIONAL:

Year-Month-Day

00:00 - 12:00 AM and 00:00 - 12:00 PM

USA:

Month/day/year

00:00 - 12:00 AM and 00:00 - 12:00 PM

4 Deactivate photo overlays

The photos taken with the Wöhler VIS 750 contain all the information shown on the camera display (status display camera display (status display, comments, position display, meter count, etc.)

- To deactivate the overlays, tap on the tick .

An x appears instead of the tick. Photos are now saved without overlays.

This setting is retained even after the camera is rebooted.

5 Voice recording

The Wöhler VIS 750 HD inspection camera can record a voice recording for each video. To do this,

the microphone must be activated before recording.

- Tap on the microphone icon to activate the microphone, see Fig. 60
- Tap the microphone icon again to deactivate the microphone if you do not want the sound to be recorded during the video recording.

6 Updating the date and time

The date and time can be changed here. These appear in the header of the display and as the file name of saved photos and videos.

- Select the desired digits and confirm with the tick.

The settings made are automatically saved and are retained after switching off and on again.

7 Distance measurement

See chapter 12.

8 Info button

- Tap the info button to access the info menu.

11.4.6 Info menu

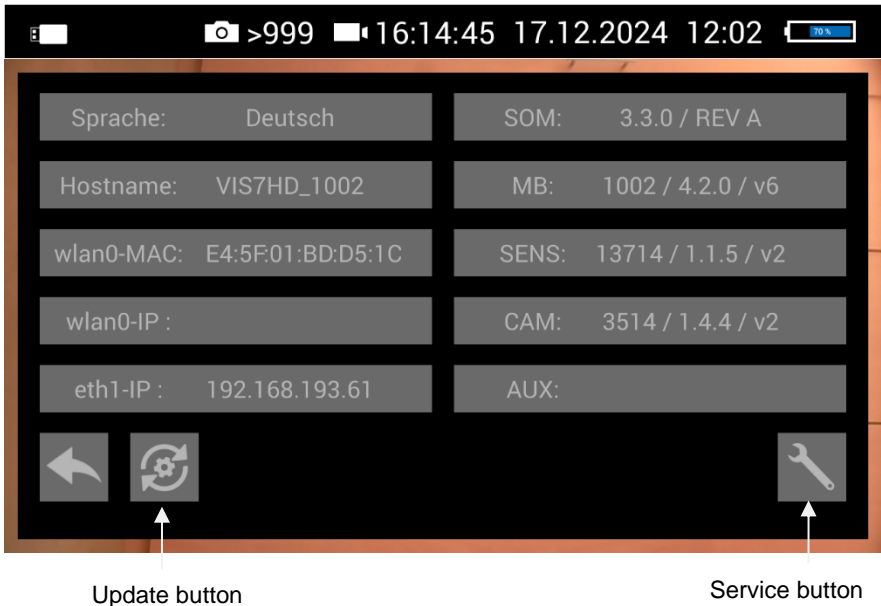

Fig. 61: Info menu

The serial number required to display the images in a browser is specified in the info menu under "Hostname", cf. 0 (transfer of image files via WLAN), the language version, the wlan0-IP and the software and hardware versions for the service are also specified.

- The service button does not need to be operated by the user, nor does the update button. Send the inspection camera to an authorized Wöhler service centre if a firmware update is to be carried out.

12 Distance measurement

The Wöhler VIS 750 HD inspection camera can measure the distance between two points in the camera head's field of view. This provides the user with information about the diameter, distances and size of the inspected objects.



NOTE!

The distance measurement can only be carried out if the rotating and swiveling camera head Ø 40 mm is connected.



NOTE!

For a more precise measurement result, a plastic dome should be used on the camera head when measuring distances.



NOTE!

Make sure the camera dome is clean to ensure accurate measurement results.

The most precise results for distance measurement are achieved in the center of the image.

*For an accurate measurement, move the camera head as close as possible to the object to be measured, see *Measuring accuracy*.*

12.1 Measuring accuracy

Distance

Distance lens plane/measuring object	Typical deviation
0 - 10 cm	± 1 cm
10 - 30 cm	± 2 cm
> 30 cm	inaccurate

12.2 Open and close distance measurement menu



Fig. 62: Icon: Distance measurement

12.3 Set measuring points



Fig. 63: Display of the distance between two measuring points



Fig. 64: Warning triangle under distance indicator

To measure an object or a distance, proceed as follows:

- Tap the display for **1 second**

The "Distance measurement" icon appears at the top right of the display.

- To exit the "Distance measurement" menu, tap the icon briefly.

- With the "Distance measurement" icon displayed, tap on the starting point of the distance to be measured.
- As soon as the camera has focused on the point and the distance to the camera lens is displayed, tap on the end point of the distance to be measured.

The distance between the two points is then displayed.



NOTE!

A warning triangle under the measured distance means that the camera head has not been recalibrated after the calibration value was last reset. In this case, first calibrate the camera head, see chapter 12.5.



Fig. 65: The measuring points can be moved by dragging

12.4 Saving the measurement results

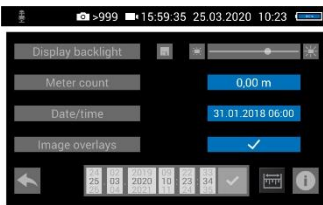

Fig. 66: Settings menu, menu item "Photo overlays" activated



NOTE!

The start and end points of the measurement can be moved at any time using drag & drop on the display. The camera then recalculates the points.

- If the displayed distance is not plausible, you can move the start and end points again. To do this, simply tap the end point again.



NOTE!

Only 2 points can be marked at the same time.

- Save your measured distance by taking a photo of it while the distance is displayed.
- Make sure that the "Photo overlays" menu item is activated in the settings menu.

12.5 Calibrating the camera head

As the different camera heads and the glass and plastic domes have different optical properties, it is necessary to calibrate the camera head after a change to ensure optimum distance measurement. The camera saves this calibration until the user resets or overwrites it.

For calibration, measure a reference value as accurately as possible. A distance of around 10 cm from the camera lens to the object is suitable for the calibration measurement. The object should be in the center of the camera display. The measuring points should not be at the edge of the display.



Fig. 67: Calibration with calibration template



NOTE!

Calibration is easy to perform using the calibration template. This is stored in the camera's internal memory. As soon as a USB stick is inserted into the monitor, the calibration template is automatically copied to the USB stick.

- Print out the template on white A4 paper.
- Fold the paper upwards by 90° at the fold.
- Place the camera head on the marked position and align the black calibration bar in the center of the image.

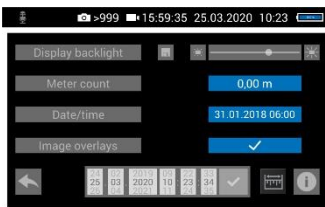





Fig. 68: "Distance measurement" button in the settings menu

To calibrate the camera head, proceed as follows:

- Tap on the icons System menu  > Settings menu  > Distance measurement 

The calibration procedure is now shown on the display.

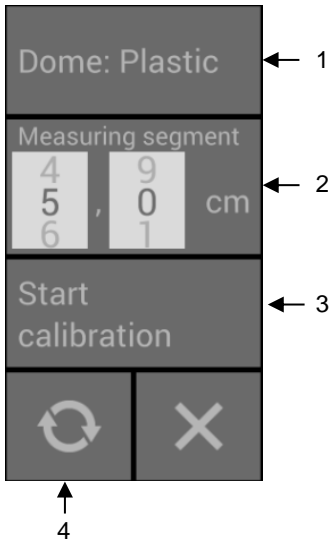

Fig. 69: Calibration menu



Fig. 70: Set the start and end point of the measuring section.

12.6 Reset calibration

The calibration menu for the camera head opens in the display.

- Select the material of the dome (plastic or glass) (1).
- If you do not want to work with the calibration template but with a reference object, set the measuring distance (2).

(Measuring distance: defined distance that is measured as a reference value during calibration).



NOTE!

The reference object can be an object that you always have with you on the construction site, for example a folding rule, a USB stick, etc.

When using the calibration template, the preset measuring distance can remain 5 cm.

- Tap on "Start calibration" (3).
- Tap the start and end point of the measuring section on the display and correct the position of the point using drag & drop if necessary.

- Tap on "Send calibration" when the end points are positioned (3).

After calibration, the display will show the normal video image again.

- Tap the reset icon (4) to reset the calibration to the default value.

13 Transfer of image files via WLAN

You have 2 options for transmitting images and videos live:

1. Access point: the Wöhler VIS 750 HD inspection camera sets up its own WLAN network.
2. Client: You dial into a stationary WLAN network with the Wöhler VIS 750 HD inspection camera and your mobile device or PC.

NOTE!

If the WLAN function has been activated on the camera, it will remain activated even after the camera is rebooted.

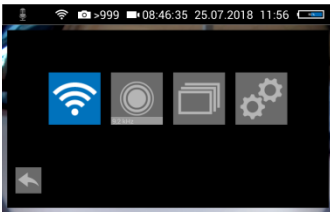

Fig. 71: System menu with activated WLAN button

- Go to the system menu, see chapter 11.



Fig. 72: WLAN icon

- Tap on the WLAN icon to activate the WLAN function of the camera system.

The camera now searches for the available networks.

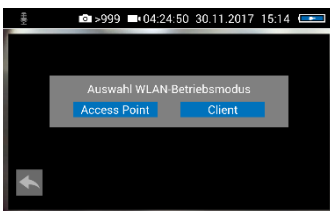

Fig. 73: Selecting the WLAN operating mode

- You will then be prompted to select the WLAN operating mode: "Access point" or "Client".

13.1 Access point: Transmission via a VIS 750 WLAN network

When the "Access Point" WLAN mode is selected, the Wöhler VIS 750 HD inspection camera sets up its own WLAN network, via which the image data can be transferred directly to a mobile device.

This method allows you to view the live images on the monitor of the Wöhler VIS 750 HD inspection camera while a colleague standing at the other end of the pipe, for example, watches the videos live on their mobile device.

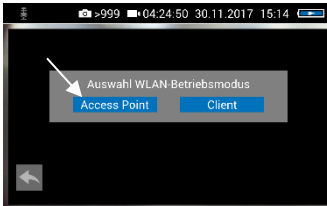

Fig. 74: Selection "Access point"

- Select "Access point".

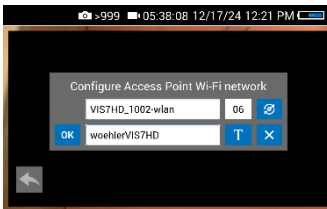

Fig. 75: Network name and password

13.1.1 Select WLAN channel if required



Fig. 76: WLAN channel marked with arrow

The network name of the Wöhler VIS 750 HD inspection camera and the password that you need to connect to your end device appear on the display.

The **network name** is composed as follows:
VIS7HD_Serial number of the camera.

The default **password** is
woehlerVIS7HD

If required, it is possible to select the WLAN channel. 13 WLAN channels can be selected.

Default setting: Channel 6



NOTE!

As a rule, it is not necessary to select a different WLAN channel.

- To select a different Wi-Fi channel, tap the number field in the top row and select the desired channel.

13.1.2 Change password or network name

You have the option of changing both the network name and the password if required. If you change the network name, you could, for example, use your own company name as the network name.

- Please note the following restrictions for the network name and password:

Network name

Network name:

The input field must not be empty.

The network name may be a maximum of 32 characters long.

password

Password:

Valid length: 8-64 characters.



NOTE!

More than 64 characters cannot be entered. If less than 8 characters are entered, the entry is highlighted in red.

Permitted characters:

Letters from a to z in upper and lower case

Digits 0 to 9

The following special characters (network name):

_ - ! # \$ % & ' () + , . / : ; < = > ? @ ^ ` { | } ~

The following special characters (password):

_ - ! " # \$ % & ' () * + , . / : ; < = > ? @ [] ^ ` { | } ~

All other characters (letters, umlauts, special characters, etc.) are not permitted.



NOTE!

Invalid characters cannot be typed in when entering the password. If the user tries to enter an invalid character, nothing happens.

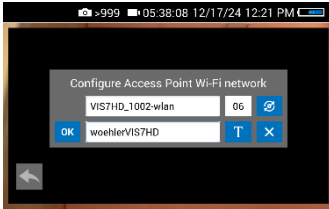

Fig. 77: Password change

- To change the network name or password, tap the corresponding field and then tap the T text button.

A keyboard opens.

- Make the corresponding change. Make sure that the password has at least 8 characters.
- To save the change, tap OK.



NOTE!

If you tap OK or switch off the camera even though the password is too short or no character has been entered for the network name, the password or network name will be reset to the last valid character combination.



Fig. 78: WLAN icon in header

The WLAN icon appears in the header bar of the display until the WLAN function is deactivated again.

- (To deactivate the WLAN function later, tap the WLAN icon in the system menu again).
- To establish the connection between the camera and the end device, proceed as follows.
- Go to the WLAN settings of your end device.
- Select the network (**VIS7HD_[serial number, 4 digits] or your self-selected network name**)
- Enter the password. It is **woehlerVIS7HD or the password you have chosen yourself**. Note that the password is case-sensitive.



NOTE!

As long as your mobile device is connected to the VIS750 network, you will of course not be able to connect it to the Internet. This is why the warning message "Internet not available" appears.

- Wait until the Wöhler VIS 750 HD inspection camera has connected to your mobile device.

Establishing a connection to the mobile device

You now have the option of displaying the video in the Wöhler Video Inspection app on your mobile device.

13.2 Client: Use of an existing WLAN network

If you select the "Client" WLAN mode, you can dial into an existing network with the Wöhler VIS 750 HD inspection camera as well as with a mobile device or WLAN-capable PC or laptop. In this way, live image transmission from the camera to the end device/laptop is also possible over a greater distance. This option can be of interest in industrial plants, for example.

NOTE!

If the Wöhler VIS 750 HD inspection camera was connected to an existing network via client mode, it will reconnect to this network after a restart. If the camera is not within range of this network when it is restarted, the WLAN is deactivated on the camera.

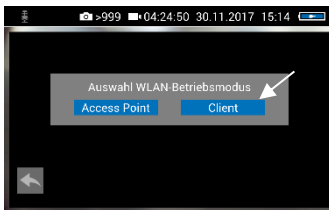

Fig. 79: Selection "Client"

- Select "Client".

All available networks appear in the camera display.

- Select a network.
- Enter the network password.
- Confirm with OK

NOTE!

The password you enter is always saved so that you do not have to enter it again the next time you dial into the same network.



Fig. 80: WLAN icon in header

- Once the connection has been successfully established, the WLAN icon appears in the header of the display. The WLAN button in the system menu is highlighted in blue until the WLAN function is deactivated again.
- Tap the arrow button to exit the system menu.

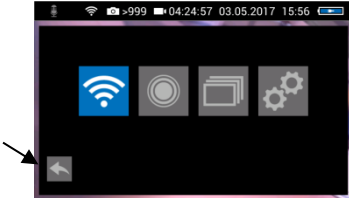

Fig. 81: System menu with WLAN button activated, arrow button highlighted

Establishing a connection to the mobile device or laptop

- To establish the connection between the camera and the end device or laptop, proceed as follows.
- Go to the WLAN settings of your end device.
- Select the same network that you dialed into with the camera.
- Enter the network password.

You now have the option of displaying the video in the Wöhler Video Inspection app on your mobile device.

14 Malfunctions

14.1 Reset



Fig. 82: Reset opening marked with arrow

It is possible to rectify certain faults by performing a reset. The reset opening is located on the back of the monitor next to the camera connection, see adjacent illustration.

- Reset 1: Press a pointed object, e.g. the wire of a paper clip, into the reset opening for approx. 2-3 seconds. All LEDs should then light up.
- Reset 2: If the LEDs do not light up after 2-3 seconds, press a pointed object into the reset opening for approx. 15 seconds. All LEDs should then light up.



NOTE!

The reset time (until all buttons light up) is 2 seconds or 15 seconds, depending on the type of reset. The reset was only successful when all LEDs light up.

14.2 Possible incidents

Malfunction notice	Possible cause	Remedy
Fast flashing of photo and video button after switching on.	Battery is empty.	Charging the battery
Monitor and camera head are switched on. No image or a faltering image appears.	Bar is broken.	Send the device in for repair.
Video recording is stopped by the camera	Interruption of the video signal, e.g. due to rod breakage	If this happens repeatedly, send the appliance in for repair.
Blurred image	Plastic dome scratched.	Replacement of the plastic dome, optional glass dome.
Camera system does not respond	Battery is empty.	Charge the battery.
	Device is defective.	Send the device in for repair.

15 Maintenance

15.1 Notes on maintenance and care

To ensure that your camera system functions properly, it must be serviced regularly. Maintenance includes activities that can be carried out by the operator.

15.2 Changing the dome of the camera head

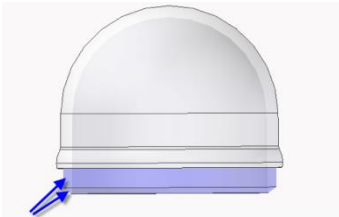

Fig. 83: Installing the camera dome

NOTE!

As supplied, the camera head is protected by a plastic dome, which can be replaced if necessary, e.g. if there are scratch marks. Alternatively, there is a glass dome that can be screwed on!

Caution: Only use the glass dome in dry areas. If the glass breaks in the waste water pipe, the camera head would be destroyed immediately.

Before replacing the dome, the thread of the new dome must be greased sparingly with silicone grease. When replacing the dome, make sure that no grease gets into the camera head and its mechanical components in particular.

When replacing the dome, make sure that the dome is tightened to the last thread. Otherwise, it cannot be guaranteed that the camera head is tight and malfunctions may occur due to the ingress of water and dirt.

15.3 Camera head

- Only clean the lens with a clean, soft and damp cloth without using cleaning agents.

15.4 Monitor

- Clean the monitor with a soft cloth.

15.5 Removing the reel

The reel with the camera rod is housed in the lower shell of the trolley. It can be easily removed from the trolley, for example to clean the reel, rod and/or lower shell (see Chap. 15.6) or to replace the reel (see chap.15.7). To remove the reel, proceed as follows:

First place the trolley in the upright position. The handle should be at a 90° angle.



Fig. 84: Trolley in upright position with handle at a 90° angle



Fig. 85: Pull up the monitor to remove it and the stand from the holder

- Remove the front flap.
- Place the monitor upright and pull it out of the holder. (see chap. 5.5)
- Loosen the union nut from the monitor cable and disconnect the monitor cable from the monitor.



Fig. 86: Remove front flap and monitor

- Store the monitor in a safe place so that it cannot get wet while cleaning the reel if you want to clean the reel.



Fig. 87: Trolley on the front

- Place the trolley on its front and remove the camera flap.



Fig. 88: Remove lower shell



Fig. 89: Pull the reel out of the reel holder

- Open the four catches on the lower shell and remove the lower shell.

- Now pull the reel out of the reel holder until the connection cable has been completely removed from the trolley.

15.6 Cleaning the reel, bar and lower shell



Fig. 90: Reel removed from the trolley

! ATTENTION!

Do not allow water to enter the plug connections to the monitor and camera head during cleaning.

- Secure the monitor plug against moisture ingress, e.g. with a film.
- If the camera head is not connected during cleaning, secure the end of the rod against moisture ingress, e.g. with a film.

! NOTE!

The waterproof camera head can remain screwed on during cleaning. In this case, ensure that the screw connection is tight



Fig. 91: Hosing off the reel and rod

! ATTENTION!

Do not use a high-pressure cleaner to clean the reel and rod, as the reel is only protected against splashing water.

- Then allow the reel with the rod to dry to avoid moisture in the trolley.



Fig. 92: The lower shell can be cleaned with a damp cloth.

! ATTENTION!

Do not spray the lower shell with running water, otherwise water may enter the gaps in the trolley.

- Clean the lower shell and the reel seat with a damp cloth.

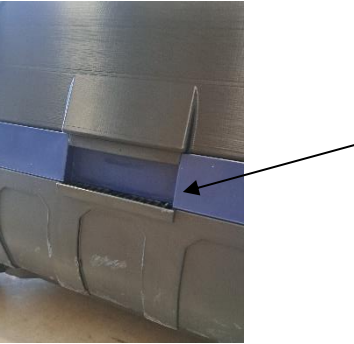

Fig. 93: Plug on the underside of the trolley

- If there is still residual liquid in the trolley after inserting the reel (see chapter 15.7), you can drain the liquid by removing the plug between the lower shell and the reel holder and then bringing the trolley into the upright position.

15.7 Inserting the reel



Fig. 94: Pull the connection cable through the opening of the reel holder

- When inserting the reel, first pull the connection cable through the opening of the reel holder.



Fig. 95: Place the reel in the reel holder

- Now place the reel in the reel seat. When doing so, make sure that the connection cable is not pinched between the reel and the reel seat. If necessary, pull on the monitor plug during insertion.

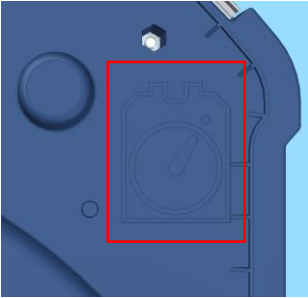

Fig. 96: Auxiliary illustration of how the reel is used



NOTE!

There is an auxiliary illustration on the inside showing how to insert the reel correctly. The rod outlet points diagonally upwards to the right.

When inserting the reel, make sure that the rod outlet points at a slight angle to the top right, as shown in the illustration.



Fig. 97: Correct fit of the reel



Fig. 98: Attaching the lower shell

- Place the lower shell on top and close the lower shell using the four black clips.
- Insert the camera flap and place the trolley in the upright position.



Fig. 99: Wrap the monitor cable around the cable domes

- Place the monitor back in the trolley. Wrap the monitor cable around the cable domes.



Fig. 100: Insert front flap

- Lower the monitor (see Chap. 5.5) and insert the front flap.

16 Guaranty and Service

16.1 Guaranty

Each Wöhler VIS 750 HD Inspection Camera will be tested in all functions and will leave our factory only after extensive quality control testing.

If used properly, the warranty period for the Wöhler VIS 750 will be 12 month from the date of sale. Not covered by the warranty are consumables, e.g. the plastic dome.

Service by non authorized personnel or making modifications to the analyzer voids any warranty.

16.2 Service

Excellent SERVICE is very important to us. Therefore, of course, we are readily available to assist you after the warranty period ends.

- Send us the Camera and we will repair it and return it to you with our package service.
- Immediate help is provided by our technical staff over the telephone.

17 Declaration of conformity

The manufacturer:

Wöhler Technik GmbH
Wöhler-Platz 1, D-33181 Bad Wünnenberg

declares that the product

product name: Wöhler VIS 750 HD Inspection Camera

complies with the key safety requirements set down in the guidelines of the Council for the Harmonization of the Legal Requirements of the Member States in relation to the electromagnetic compatibility (2014/53/EU).

The following standards were availed of to evaluate the product in respect of the electromagnetic compatibility:

ETSI EN 301 489-1 V2.2.3 (2019-11)
ETSI EN 301 489-17 V3.3.1 (2024-09)
EN 61000-6-2:2019
EN 61000-3-2:2014 / IEC 61000-3-2:2014
EN 61000-3-3:2013 / IEC 61000-3-3:2013
EN 62479: 2010
EN 62311: 2020
ETSI EN 300 328 V2.2.2 (2019-07)
ETSI EN 300 330 V2.1.1 (2017-02)
EN IEC 62368-1:2020 + A11:2020
IEC 62368-1:2018 (Ed. 3)
EN 62368-1:2014 + AC:2015 + A11:2017
IEC 62368-1:2014 (Ed. 2) + Cor.:2015

Bad Wünnenberg, 22.04.2025



Dr. Michael Poepplau, Geschäftsführer/Managing Director

18 UKCA Declaration of Conformity

The manufacturer:

Wöhler Technik GmbH
Wöhler-Platz 1, D-33181 Bad Wünnenberg

hereby declares that the following product:

Product: HD Inspection Camera
Model: Wöhler VIS 750

is in conformity with the requirements of the following legislation:
Radio equipment Regulations 2017

The following standards were used to access the products in terms of electromagnetic compatibility:

ETSI EN 301 489-1 V2.2.3 (2019-11)
ETSI EN 301 489-17 V3.3.1 (2024-09)
BS EN 61000-6-2:2019
BS EN 61000-3-2:2014 / IEC 61000-3-2:2014
BS EN 61000-3-3:2013 / IEC 61000-3-3:2013
BS EN 62479: 2010
BS EN 62311: 2020
ETSI EN 300 328 V2.2.2 (2019-07)
ETSI EN 300 330 V2.1.1 (2017-02)
BS EN IEC 62368-1:2020 + A11:2020
IEC 62368-1:2018 (Ed. 3)
BS EN 62368-1:2014 + AC:2015 + A11:2017
IEC 62368-1:2014 (Ed. 2) + Cor.:2015

Bad Wünnenberg, 22.04.2025



Dr. Michael Poeplau, Geschäftsführer/Managing Director